

# The Belmont 048

THE ECONOMY LIGHT

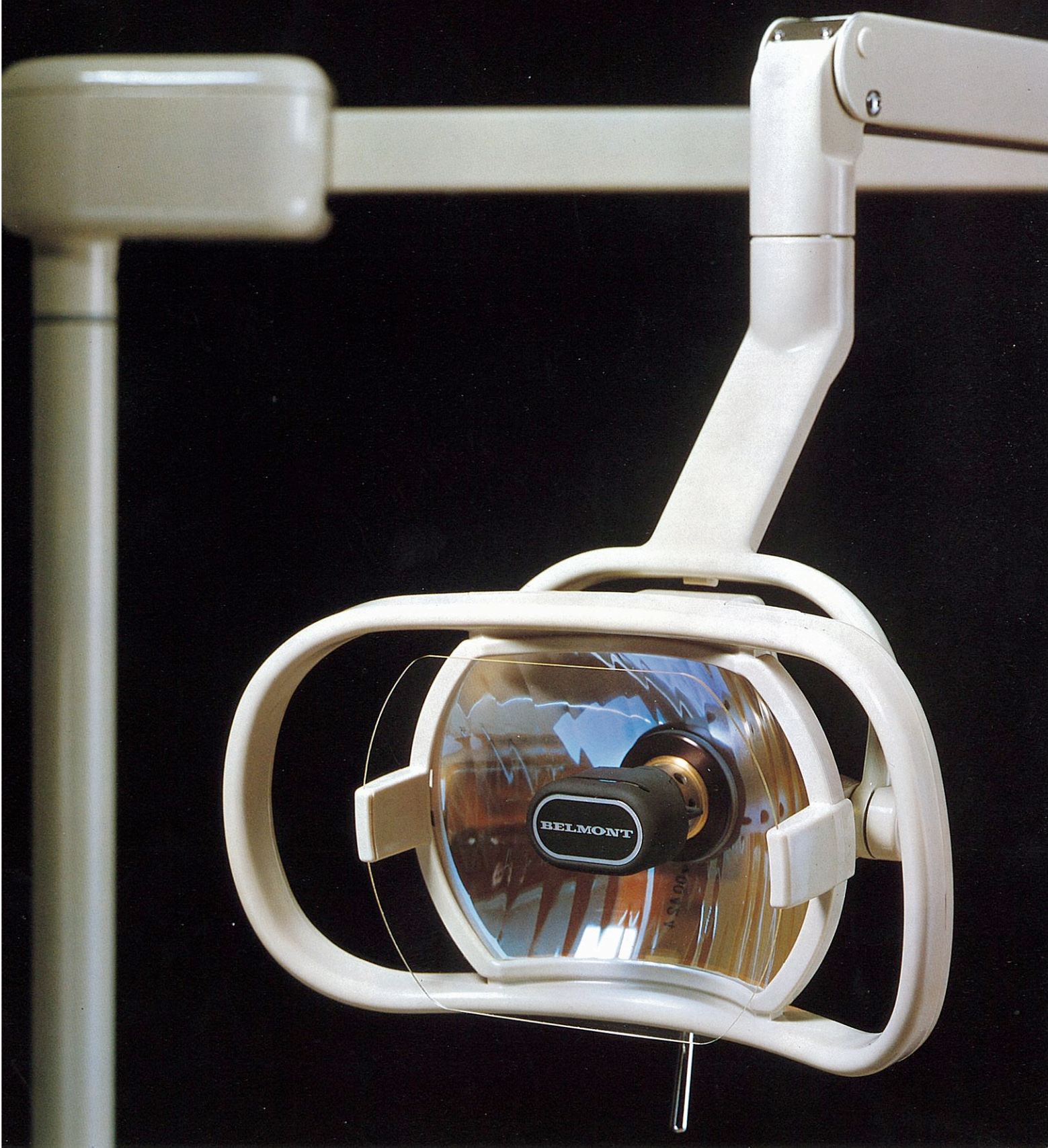

The Belmont 048 incorporates the latest advances in dental lighting technology. The light is colour matched to natural daylight, is easily cleaned, has a dual intensity on-off control and smooth easy positioning. In fact the 048 has everything you have ever wanted in an operating light.

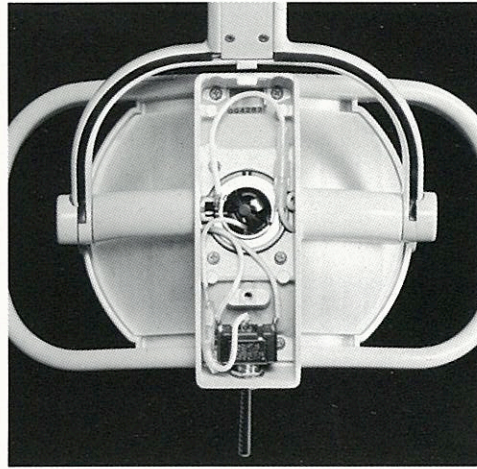
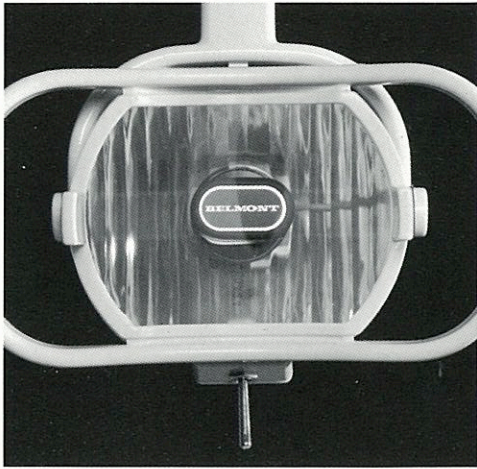

**Dual Intensity On-Off Control**

- Switch is conveniently located in light head enabling intensity to be changed from seated position.
- Low intensity – for longer lamp life and examining facial surfaces.
- High intensity – for colour matching and examining lingual surfaces.

**Changing the Bulb**

- The Halogen lamp is easily replaced without the need for special tools.

**TRACK LIGHT**

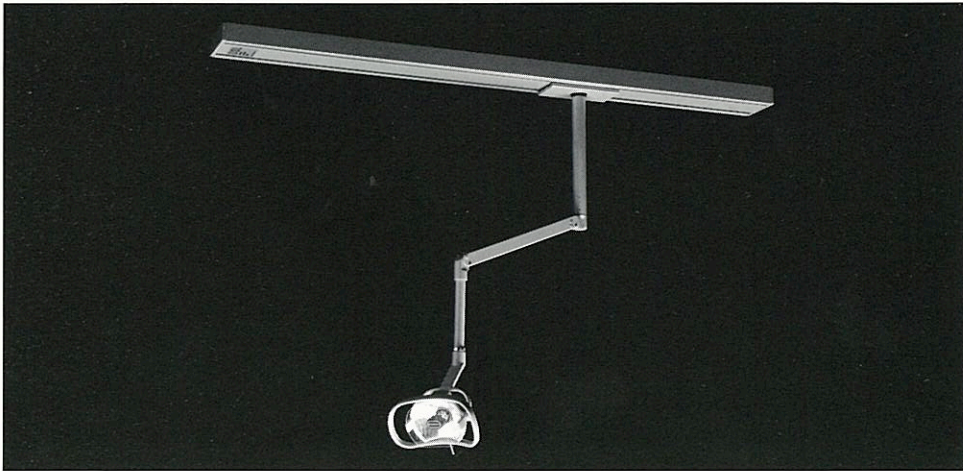

**Smooth, Balanced Movement**

- Lightweight, long arms provide for easy positioning and greater reach.
- Drift-free vertical rotation.
- Counter balanced arms.

And these exclusive features:

- Quartz-Tungsten-Halogen Lamp
- Colour-corrected to full colour spectrum
- Low voltage 12V
- Contoured reflector to overcome partial blockage

**Mounting** – 048 can be mounted on the unit, wall or ceiling see below.

**UNIT MOUNT TYPE**

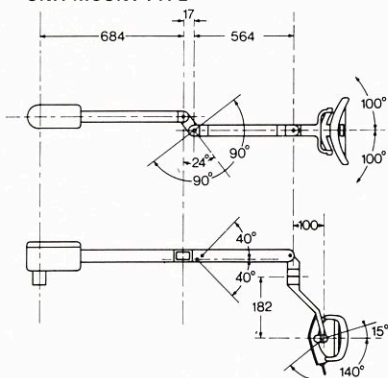

Spigot and Light Post included in Belmont Units (Optional extra for other manufacturers – please specify the spigot size).

**CEILING AND WALL MOUNT TYPE**

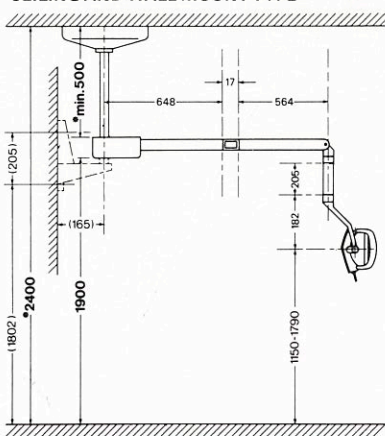

**TRACK LIGHT**

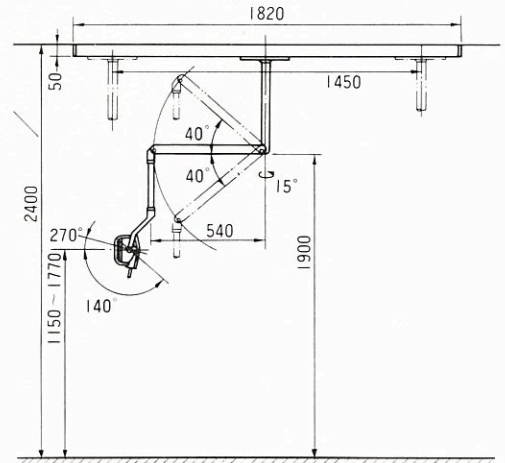

The manufacturers reserve the right to alter specifications without prior notice

